

Oberflächenauswahl:

Die Bestellnummer setzt sich aus drei Segmenten zusammen:

**Oberflächenmaterial + Materialstärke +
Oberflächenfarbe/Oberflächenbeschaffenheit**

So finden Sie die richtige Bestellnummer der Oberfläche:

1. Suchen Sie sich das Oberflächenmaterial aus und notieren Sie sich die entsprechende Nummer.
2. Jetzt wählen Sie die Materialstärke aus. (Bitte beachten Sie, dass diese den anderen Bauteilen entsprechen muss und stark genug ausgelegt sein sollte, um später ausreichend Schutz zu gewähren.) Erweitern Sie die Bestellnummer um die entsprechende Angabe, indem Sie die Materialstärke im Zehnersystem anfügen. (Beispiel: 6,5 mm = 65 / 9,0 mm = 90)
3. Nun suchen Sie sich die Oberfläche und Farbe aus und erweitern die Bestellnummer wiederum um diese Auswahl.

Beispiel:

X100 + 90 + k20r = x10090k20r
(Multiplexholz) + (9mm stark) + (rote PVC-Oberfläche)

Wir schneiden Ihnen das Material (ob Oberfläche oder Aluminium-Profile) auch passgenau zu. Dafür berechnen wir Ihnen 10 % Verschnitt sowie die Arbeitszeit.

Surface choice:

The order number consists of three segments

Surface material + material strength + surface colour/surface composition

To find the correct order number of the surface so:

1. *Look for the surface material of your choice and note down the corresponding number.*
2. *Now select the material strength and add this number to the material number. (Note: the material thickness should correspond to other Case accessory's and should be strongly enough to grant sufficient protection) Extend the order number by the corresponding material strength in mm converted into the decimal system. (Example: 6.5 mm = 60 / 9,0 mm = 90)*
3. *Now choose your surface and colour and extend the order number in turn by this.*

Example:

X100 + 90 + k20r = x10090k20r
(Plywood) + (9 mm strong) + (red PVC surface)

We cut for you also the Material (surface wood or aluminium extrusions)
We calculate to the material an cutting lost of 10% plus working time.

Oberflächenmaterial / Surface

X10..

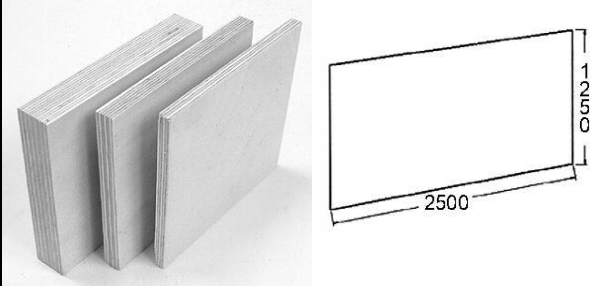

Multiplexholz unbehandelt, Schichtbauweise wasserfest druckverleimt, 2500 x 1250 mm
Plywood untreated, water proof glued, 2500 x 1250 mm

X11..

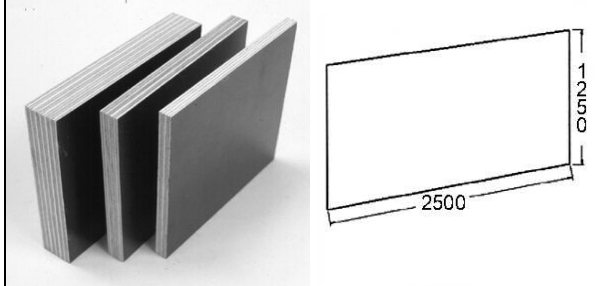

Multiplexholz phenolbehandelt, Schichtbauweise wasserfest druckverleimt, 2500 x 1250 mm
Plywood phenol treated waterproof glued, 2500 x 1250 mm

X12..

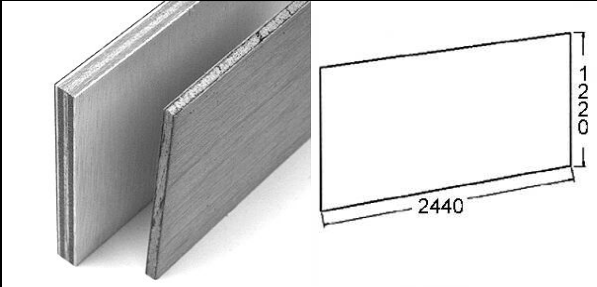

Gabun Sperrholz, Plattenschichtbauweise druckverleimt, 2440 x 1220 mm
Gabun plywood, 2440 x 1220 mm

X15030s

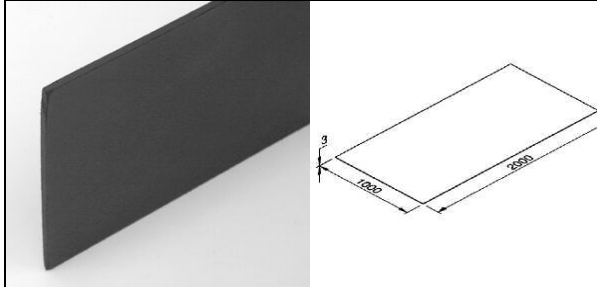

Kunststoffplatte 3 mm, schwarz, extrem leicht, 1000 x 2000 mm
Plastic plate (PVC), black, very light, 1000 x 2000 mm

X15..

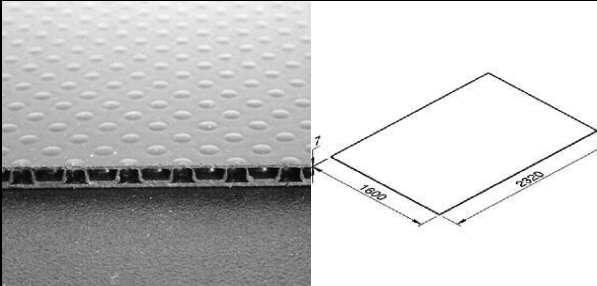

Polypropylen Kunststoffplatte, extrem leicht, 1600 x 2320 mm
Polypropylene PVC, very light, 1600 x 2320 mm

x..k. / x..k.k01

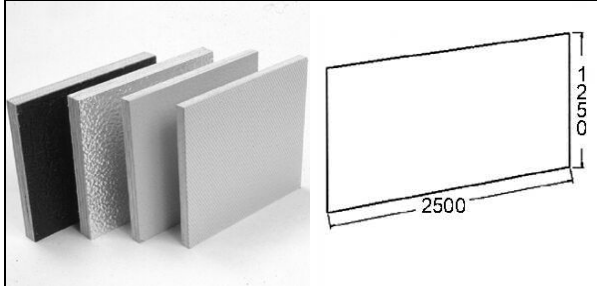

Spanplatte geleimt / MDF, ohne Nut und Feder, zum Innenausbau, 2500 x 1250 mm
Plywood / MDF, for interiors, 2500 x 1250 mm

Polypropylen-Oberflächenfarben Polypropylen surface colors

Rot



rot
red

Blau



blau
blue

Grau











grau
gray

Schwarz

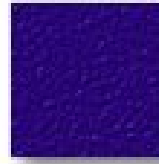

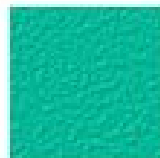
schwarz
schwarz

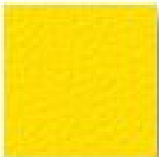
Oberflächenfarben / Surface colours

k20r	k20b	k20g	k20nb
			
Beschichtungsfolie PVC rot <i>PVC coating foil red</i>	Beschichtungsfolie PVC blau <i>PVC coating foil blue</i>	Beschichtungsfolie PVC grau <i>PVC coating foil gray</i>	Beschichtungsfolie PVC nacht-blau <i>PVC coating foil night-blue</i>
k20ar	k20s	k20t	K20w
			
Beschichtungsfolie PVC grün <i>PVC coating foil green</i>	Beschichtungsfolie PVC schwarz <i>PVC coating foil black</i>	Beschichtungsfolie PVC türkis <i>PVC coating foil turquoise</i>	Beschichtungsfolie PVC weiß <i>PVC coating foil white</i>
k20g	k20p	k30g	k30b
			
Beschichtungsfolie PVC gelb <i>PVC coating foil yellow</i>	Beschichtungsfolie PVC petrol <i>PVC coating foil petrol</i>	Con-Pearl Plattenfarbe grau <i>Con-Pearl surface colour gray</i>	Con-Pearl Plattenfarbe blau <i>Con-Pearl surface colour blue</i>
k30s	k30r	k00	k05
			
Con-Pearl Plattenfarbe schwarz <i>Con-Pearl surface colour black</i>	Con-Pearl Plattenfarbe rot <i>Con-Pearl surface colour red</i>	Aluminium Stuko-grob 0,5 mm stark <i>Aluminum Stucco-fine 0.5 mm thick</i>	Aluminium Stuko-fein 0,5 mm stark <i>Aluminum Stucco-fine 0.5 mm thick</i>